

Features

Frequency range : 1MHz to 200MHz
 SMD seam sealing ceramic package
 Supply voltage : 1.8V ~ 3.3V
 CMOS output
 Tri-state function available
 Dimensions L 2.5 x W 2.0 x H 0.8 mm
 AEC-Q100 compliant (option)
 RoHS compliant & Pb free

Applications

Networking, Server, Storage
 Wireless communications
 Fibre channel, Ethernet, SATA, SAS,
 PCI-E, USB, WLAN, xDSL, xPON
 PC mainboard, Notebook, HDD, SSD,
 Graphics card, Computer peripherals
 Audio, Video, Gaming, Printer, DSC,
 IP CAM, Consumer products

Electrical Characteristics

Item	8WJ	Conditions
Frequency Range (F ₀)	1MHz ~ 125MHz	V _{DD} =1.8V
	1MHz ~ 200MHz	V _{DD} =2.5V, 3.3V
Frequency Stability (F _{stab})	±50 ppm	Note [2]
Operating Temperature Range (T _{OTR})	-40°C ~ +85°C	
	-40°C ~ +105°C	
Supply Voltage (V _{DD})	Typ. 1.8V (1.65V ~ 1.95V) Typ. 2.5V (2.25V ~ 2.75V) Typ. 3.3V (2.97V ~ 3.63V)	
Current Consumption (I _{DD})	22 mA Max.	No load, F ₀ =110MHz, V _{DD} =2.5V~3.3V
OE Mode Disable Current (I _{od})	18 mA Max.	OE=GND, output is Pulled Down
PDB Mode Standby Current (I _{std})	400 µA Typ.	OE=GND, output is Pulled Down
Output Type	CMOS	
Output Load (C _L)	15 pF	
Duty Cycle	45% ~ 55%	
Rise & Fall Time (T _r / T _f)	1.5 ns Typ.	C _L =15pF, 10%~90% V _{DD} high drive (V _{DD} =2.5V, 3.3V)
Output Voltage High (V _{OH})	V _{DD} - 0.4 Min.	I _{OH} =-4mA, I _{OL} =4mA, Standard Drive
Output Voltage Low (V _{OL})	0.4 Max.	
Input Voltage High (V _{IH})	70% V _{DD} Min.	Pin1, OE
Input Voltage Low (V _{IL})	30% V _{DD} Max.	
Start-up Time (T _{start})	5ms Typ. / 7ms Max.	Note [3]
OE Enable/Disable Time (T _{oe})	10 nS Max.	Note [4]
Resume Time (T _{resume})	7 mS Max.	In PDB mode, Ta=25°C, C _L =15pF
PK-PK Period Jitter (T _{jitt})	200pS Typ. / 300pS Max.	F ₀ =125MHz, V _{DD} =2.5V or 3.3V
	220pS Typ. / 300pS Max.	F ₀ =125MHz, V _{DD} =1.8V
Phase Jitter, RMS (T _{phj})	0.7pS Typ. / 1.0pS Max.	F ₀ =125MHz, V _{DD} =3.3V, integrated 12kHz~20MHz
First Year aging (F _{aging})	±1.5 ppm Max.	at 25°C±3°C
10 Years Aging	±5 ppm Max.	
Storage Temperature Range (T _{STR})	-55°C ~ +125°C	

Notes:

- [1] All electrical specifications in the above table are specified with 15pF output load and for all V_{DD} unless otherwise stated.
- [2] Inclusive of frequency tolerance at 25°C, 1st year aging at 25°C, and variations over operating temperature, supply voltage, and load.
- [3] Measure from the time V_{DD} reaches its rated minimum value.
- [4] OE function; $T_a = 25^\circ\text{C}$, $C_L = 15\text{pF}$. Add one clock period to this measurement for a usable clock output.

Dimensions & Pin Configuration

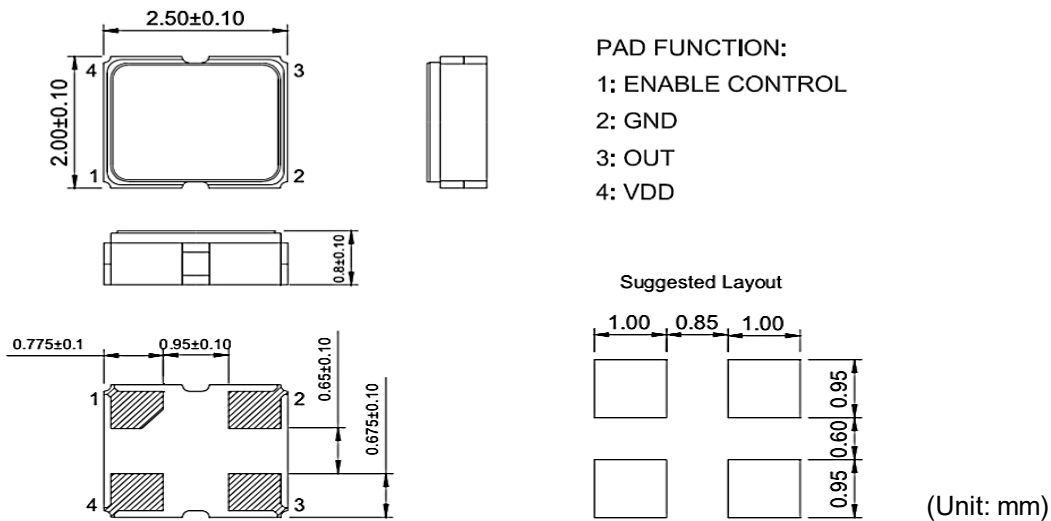

Pin	Symbol	Functionality	
1	OE	Output Enable	H or Open, Specified frequency output. L: output is high impedance. Only output driver is disabled.
		PDB mode (Option)	H or Open, Specified frequency output. L: output is low. Device goes to sleep mode. Supply current reduces to I_{std} .
2	GND	Ground	Electrical ground
3	OUT	Output	Oscillator output
4	VDD	Power	Power supply voltage

Test Circuit and Waveform

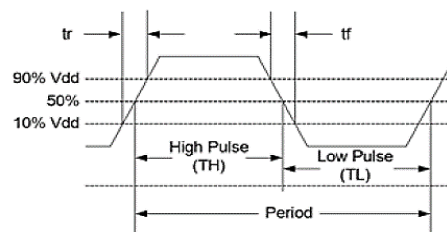
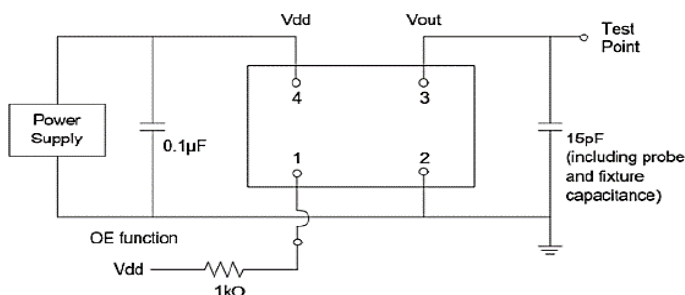

Test Diagram

Startup Timing (OE mode)

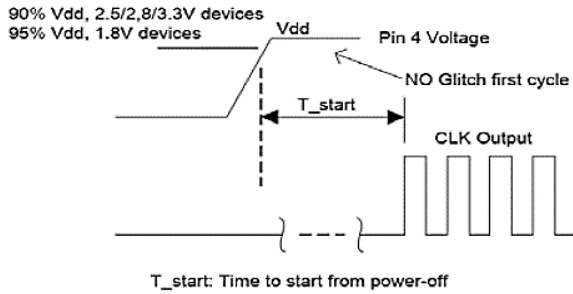

Standby Resume Timing (PDB mode)

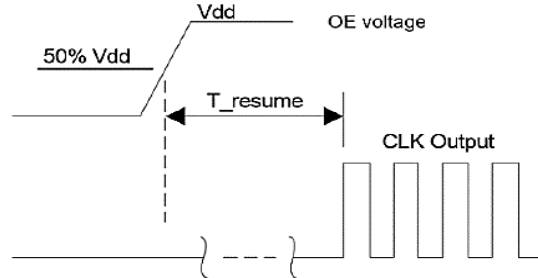

OE Enable Timing

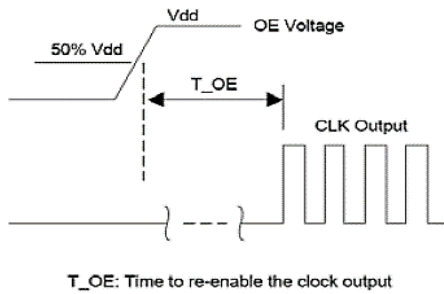

OE Disable Timing

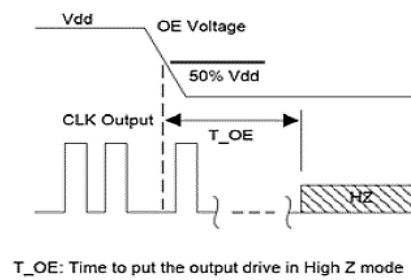

Ordering Information

8WJ - 30.000M B E - T

Frequency in Hz

Please contact us for available frequencies

Packaging Method

T Tape & Reel

Supply Voltage

B	3.3 V
C	2.5 V
D	1.8 V

Frequency Stability

E	± 50 ppm (-40°C ~ +85°C)
J	± 50 ppm (-40°C ~ +105°C)

Making

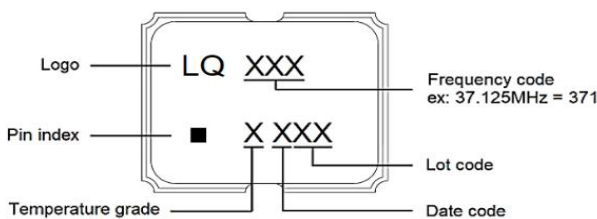

Temperature grade	Temperature range
I	-40°C ~ +85°C
E	-40°C ~ +105°C

Packing

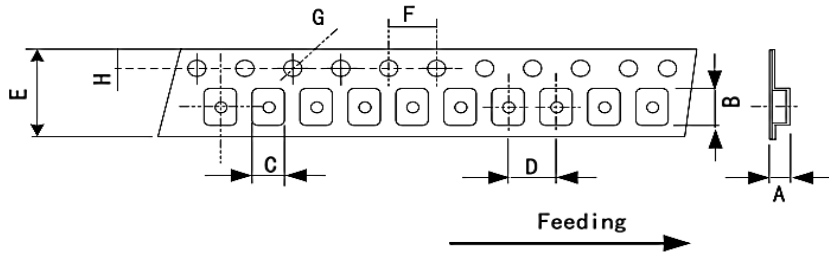

Dimensions	A	B	C	D	E	F	G	H	(Unit:mm)
	1.15 ±0.05	2.70 ±0.05	2.25 ±0.05	4.00 ±0.10	8.00 ±0.20	4.00 ±0.10	1.55 ±0.05	1.75 ±0.10	

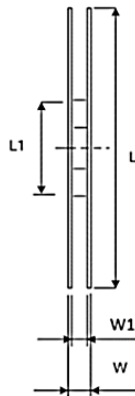
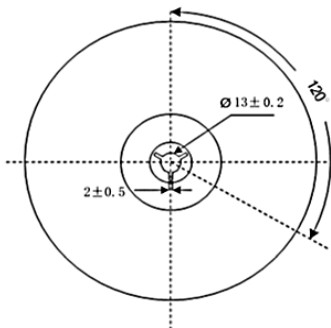
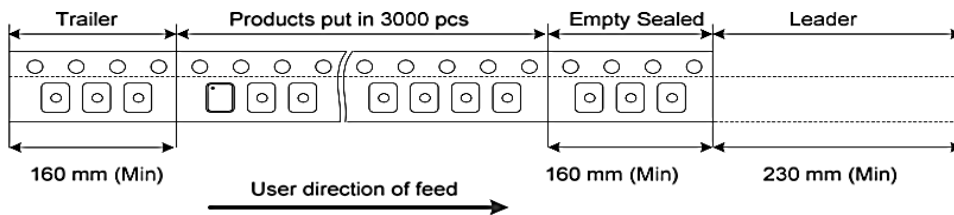

Dimensions	L	L1	W	W1	Standard Reel Quantity is 3,000 pcs per reel (Unit:mm)
	180 0/-3	60 +1/0	11.4 ±1	9 ±0.3	

Reflow Profile

Solder melting point : 220°C ± 10°C, 60 sec. Min.

Peak temperature : 260°C ± 10°C, 10 sec. Min.

